

Operating Instructions

Dynamic Power Non Switching

STEREO AMPLIFIER

A-70

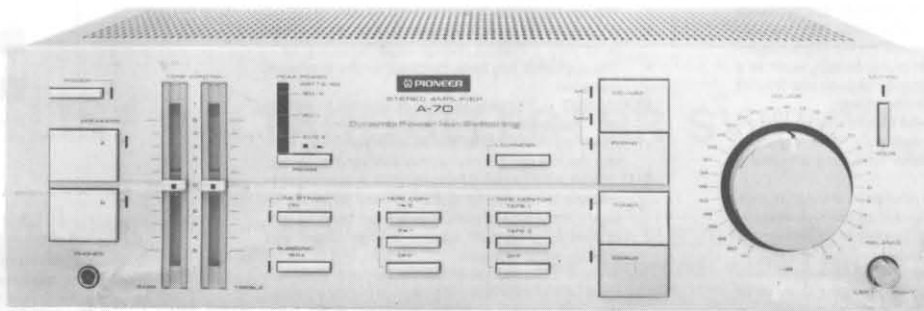

Thank you for buying this Pioneer product. Please read through these operating instructions and then you will know how to operate your model properly. After you have finished reading the instructions, put them away in a safe place for future reference.

These operating instructions are based on the model HE, and they can be used for the HB, YP, KU, KC, S, S/G, models. The differences between the models are given below.

HE model:

For Europe ('HE' stamped on packing case): A 2-point (a.c. 220 Volts ~ /240 Volts ~) voltage selector switch is provided.

HB model:

For U.K. ('HB' stamped on packing case): A 2-point (a.c. 220 Volts ~ /240 Volts ~) voltage selector switch is provided.

YP model:

For Australia ('YP' stamped on packing case): A 2-point (a.c. 220 Volts ~ /240 Volts ~) voltage selector switch is provided.

KU and KC models:

For U.S.A. and Canada ('KU' or 'KC' stamped on packing case): power line voltage is AC 120 volts.

S and S/G models:

For destinations excluding above ('S' or 'S/G' stamped on packing case): A 4-point (AC 110V/120 V/220 V/240 V) voltage selector switch is provided.

- Depending upon the model, the design of the power plug and the power outlet differs.

The line voltage selector switch is located on the rear panel of the unit. Please check that it is set properly before plugging the power cord into the outlet. If it is not set properly, change the setting of it according to the LINE VOLTAGE SELECTION on page 3.

KU and KC models are not provided with LINE VOLTAGE SELECTOR switch.

IMPORTANT NOTICE (For KU and KC models)

The serial number for this equipment is located on the rear panel. Please write this serial number on your enclosed warranty card and keep in a secure area. This is for your security.

WARNING: TO PREVENT FIRE OR SHOCK HAZARD, DO NOT EXPOSE THIS APPLIANCE TO RAIN OR MOISTURE.

 **PIONEER®**

SAFETY INSTRUCTIONS [FOR KU MODEL]

READ INSTRUCTIONS — All the safety and operating instructions should be read before the appliance is operated.

RETAIN INSTRUCTIONS — The operating instructions should be retained for future reference.

HEED WARNING — All warnings on the appliance and in the operating instructions should be adhered to.

FOLLOW INSTRUCTIONS — All operating and use instructions should be followed.

WATER AND MOISTURE — The appliance should not be used near water — for example, near a bathtub, washbowl, kitchen sink, laundry tub, in a wet basement, or near a swimming pool, etc.

LOCATION — The appliance should be installed in a stable location.

WALL OR CEILING MOUNTING — The appliance should not be mounted to a wall or ceiling.

VENTILATION — The appliance should be situated so that its location or position does not interfere with its proper ventilation. For example, the appliance should not be situated on a bed, sofa, rug, or similar surface that may block the ventilation openings; or, placed in a built-in installation, such as a bookcase or cabinet that may impede the flow of air through the ventilation openings.

HEAT — The appliance should be situated away from heat sources such as radiators, heat registers, stoves, or other appliances (including amplifiers) that produce heat.

POWER SOURCES — The appliance should be connected to a power supply only of the type described in the operating instructions or as marked on the appliance.

POWER-CORD PROTECTION — Power-supply cords should be routed so that they are not likely to be walked on or pinched by items placed upon or against them, paying particular attention to cords at plugs, convenience receptacles, and the point where they exit from the appliance.

CLEANING — The appliance should be cleaned only with a polishing cloth or a soft dry cloth. Never clean with furniture wax, benzine, insecticides or other volatile liquids since they may corrode the cabinet.

POWER LINES — An outdoor antenna should be located away from power lines.

NONUSE PERIODS — The power cord of the appliance should be unplugged from the outlet when left unused for a long period of time.

OBJECT AND LIQUID ENTRY — Care should be taken so that objects do not fall and liquids are not spilled into the enclosure through openings.

DAMAGE REQUIRING SERVICE — The appliance should be serviced by Pioneer authorized service center or qualified service personnel when:

- The power-supply cord or the plug has been damaged; or
- Objects have fallen, or liquid has been spilled into the appliance; or
- The appliance has been exposed to rain; or
- The appliance does not appear to operate normally or exhibits a marked change in performance; or
- The appliance has been dropped; or the enclosure damaged.

SERVICING — The user should not attempt to service the appliance beyond that described in the operating instructions. For all other servicing, contact the nearest Pioneer authorized service center.

OUTDOOR ANTENNA GROUNDING — If an outside antenna is connected to the antenna terminal, be sure the antenna system is grounded so as to provide some protection against voltage surges and built up static charges.

In the U.S.A. section 810 of the National Electrical Code, ANSI/NEPA No. 70-1981, provides information with respect to proper grounding of the mast and supporting structure, grounding of the lead-in wire to an antenna discharge unit, size of grounding conductors, location of antenna-discharge unit, connection to grounding electrodes, and requirements for the grounding electrode. See Fig. A.

EXAMPLE OF ANTENNA GROUNDING AS PER NATIONAL ELECTRICAL CODE INSTRUCTIONS

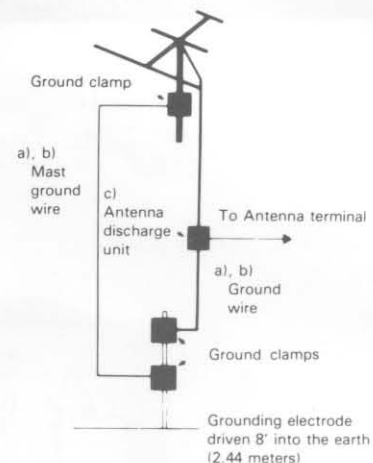

Fig. A

- Use No. 10 AWG (5.3 mm²) copper or No. 8 AWG (8.4 mm²) aluminum or No. 17 AWG (1.0 mm²) copper-clad steel or bronze wire, or larger as ground wires for both mast and lead-in.
- Secure lead-in wire from antenna to antenna discharge unit and mast ground wire to house with stand-off insulators, spaced from 4 feet (1.22 meters) to 6 feet (1.83 meters) apart.
- Mount antenna discharge unit as closely as possible to where lead-in enters house.

IMPORTANT



The lightning flash with arrowhead, within an equilateral triangle, is intended to alert the user of the presence of uninsulated "dangerous voltage" within the product's enclosure that may be of sufficient magnitude to constitute a risk of electric shock to persons.

CAUTION
RISK OF ELECTRIC SHOCK
DO NOT OPEN

CAUTION:
TO PREVENT THE RISK OF ELECTRIC SHOCK, DO NOT REMOVE COVER (OR BACK). NO USER-SERVICEABLE PARTS INSIDE. REFER SERVICING TO QUALIFIED SERVICE PERSONNEL.



The exclamation point within an equilateral triangle is intended to alert the user of the presence of important operating and maintenance (servicing) instructions in the literature accompanying the appliance.

IMPORTANT [FOR HB AND YP MODELS]

To prevent electric shock, do not remove cover. No user serviceable parts inside; refer servicing to qualified service personnel. This apparatus is fitted with AC mains power outlet(s) for convenient connection of additional Hi-Fi component(s).

For details on the outlet(s), see REAR PANEL FACILITIES.

Make all connections to the AC outlet(s) and the signal terminals first. Connect the plug to the wall socket last; make sure that the power switch is off.

Disconnect the wall plug when the equipment is not in regular use, e.g. when on vacation.

FOR USE IN UNITED KINGDOM AND AUSTRALIA

CAUTION 240 V: Mains supply voltage is factory adjusted at 240 V.

FOR USE IN UNITED KINGDOM

The wires in this mains lead are coloured in accordance with the following cord:

Blue:	Neutral
Brown:	Live

As the colours of the wires in the mains lead of this apparatus may not correspond with the coloured marking identifying the terminals in your plug proceed as follows:

The wire which is coloured blue must be connected to the terminal which is marked with the letter N or coloured black.

The wire which is coloured brown must be connected to the terminal which is marked with the letter L or coloured red.

Equipment sold in the U.K. is not supplied with a power plug.

CONTENTS

Features	4	Operations	10
Rear Panel Facilities and Connections	5	Troubleshooting	14
Connecting the Components	7	Specifications	15
Front Panel Facilities	8		

LINE VOLTAGE SELECTOR SWITCH

You will find the line voltage selector switch on rear panel. Before your model is shipped from the factory, the switch is set to the power requirements of the destination; nevertheless, you should check that it is set properly before plugging the power cord into the AC outlet. If the voltage is not properly set or if you move to an area where the voltage requirements differ, adjust the selector switch as follows. Before adjusting, disconnect the power cord.

KU (for U.S.A.) and KC (for Canada) models are not provided with LINE VOLTAGE SELECTOR switch.

For U.K. Model (HB) and Europe Model (HE)

- For U.K. ('HB' stamped on packing case): Power line voltage is 240 volts.
1. Loosen the screw on the VOLTAGE SELECTOR plug with a Phillips screwdriver, then take out the plug.
 2. Re-install the plug with its cutaway section exposing the correct voltage indication as illustrated.
 3. Tighten the mounting screw.

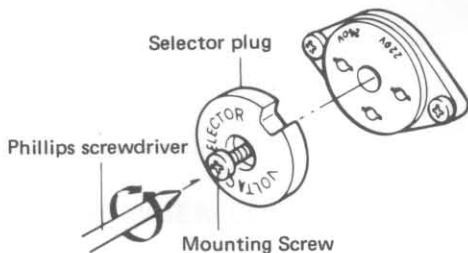

For General Export Model (S and S/G)

- For general export model ('S' or 'S/G' stamped on packing case): A 4-point (110 V/120 V/220 V/240 V) voltage selector switch is provided on the rear panel.
1. Prepare a medium size screwdriver.
 2. Insert the screwdriver into the arrow on the voltage selector and adjust so that the tip of the arrow points to the voltage value of your area.

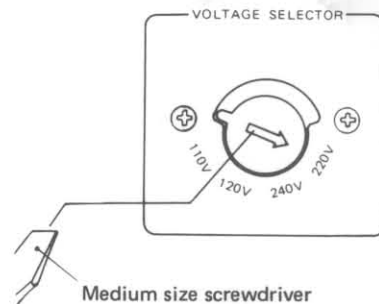

FEATURES

DYNAMIC POWER NON-SWITCHING

Fulfills the fundamental purpose of an amplifier by faithfully amplifying the music source and driving the speakers without losing any of the original feeling of the music source. The worst scourge of listening pleasure, the switching problem, has been eliminated by use of the Non-Switching Amplifier System. Dynamic Power Supply circuitry has been used in keeping with the expansion of the dynamic range of modern digital audio equipment. This is the Dynamic Power Non-Switching that has made quality and high power a reality.

SIMPLE 2 AMPLIFIER CONSTRUCTION FROM MC INPUT TO SPEAKERS

High level tuner, CD/AUX and tape inputs are connected to the Dynamic Power Non-Switching. The unit consists of a high gain amplifier and a complete DC servo that has no coupling capacitors. In addition, for PHONO input composition has been kept simple, and even with MC reproduction the amplification circuit right through to the speaker output has only two amplifiers.

LINE STRAIGHT FUNCTIONS

A line straight function which bypasses the tone control and loudness control circuits has been installed. The simple circuit construction which is so important to sound purity can be easily selected by a flip of the switch.

PEAK POWER INDICATOR

Peak power values are indicated by three point LED on the highly responsive circuit. A switch has been provided to cope with both low output levels and high output levels.

DC SERVO AND HIGH GAIN EQUALIZER

Careful consideration has been given to the task of fully amplifying the micro signals of the MC cartridge, the most widely used cartridge these days. The first stage uses a low-noise, high-gain FET while the second stage uses a one chip dual operational amplifier. As the signal amplification apparatus and the DC servo amplifier are contained in identical chips, excellent stability is obtained. In practice, a high S/N of 70 dB (220 μ V) has been obtained. The RIAA component, which controls sound quality, consists of a mylar capacitor and a special resistor, while in the DC servo circuit a resin membrane capacitor has been used.

4 Ω SPEAKERS POSSIBLE

By operating the speaker impedance switch in the rear panel it is possible to use 4 Ω speakers.

STRONG POWER SOURCE

In the power source area which controls sound, the two sides of the large capacity transformer are divided into a power amplifier and a voltage amplifier. Features such as a total 40,000 μ F condenser in the power amplifier have been included to produce a strong power source with plenty of extra capacity.

REAR PANEL FACILITIES AND CONNECTIONS

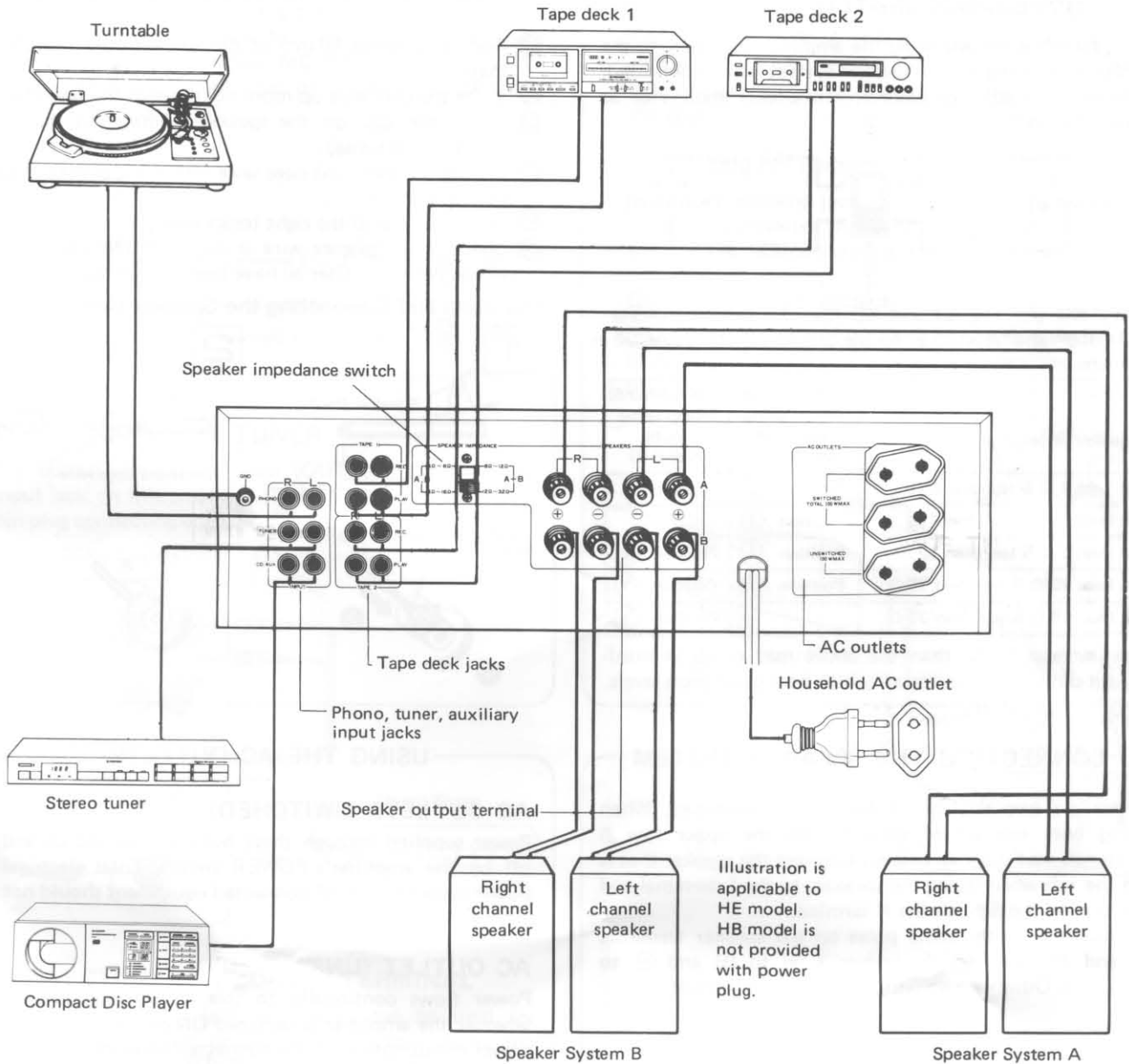

CAUTIONS WHEN CONNECTING

- Turn on stereo amplifier and component power switches only after completing all connections between the stereo system.
- For connecting, use the cords accompanying the various components (tape deck, tuner, etc.). No accessory cords are included with the amplifier.
- On the stereo amplifier input/output jacks, L is the left channel and R is the right channel. Be sure you do not get the left and right channels mixed up when connecting.
- Plug in the connecting cord pin plug firmly. If the plug is not in properly, it can cause an absence of sound or static.

OPERATION OF THE SPEAKER IMPEDANCE SWITCH

This switch is for adjusting the amplifier according to the impedance rating of the speaker system being connected. The switch is adjusted according to speaker impedance as shown below

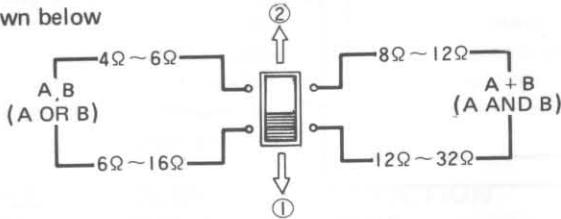

Only KU (for U.S.A.) and KC (Canada) models indicate "A OR B" and "A AND B" on the SPEAKER IMPEDANCE switch.

Speaker Impedance Rating	A, B (A OR B) (When using only one set, A or B)	A+B (A AND B) (When using both A and B)
At least 4 Ω & less than 6 Ω	Position ②	
At least 6 Ω & less than 8 Ω	Position ①	
At least 8 Ω & less than 12 Ω	Position ①	Position ②
At least 12 Ω & less than 16 Ω	Position ①	Position ①
At least 16 Ω & less than 32 Ω		Position ①

Any settings other than the above may result in insufficient output or unnecessarily high heat generation levels.

CONNECTING THE SPEAKER CORDS

- 1 Peel away about 10 mm of the speaker cord insulating material.
- 2 Twist the core wire up more tightly with the fingertips.
- 3 Screw the cap on the speaker terminal to the left (counter-clockwise).
- 4 Fit the speaker cord core wire into the gap opened up behind the cap.
- 5 Screw the cap to the right (clockwise).
- 6 Check that the core wire is not protruding from any of the terminals after all have been connected.

Handling and Connecting the Speaker Cords

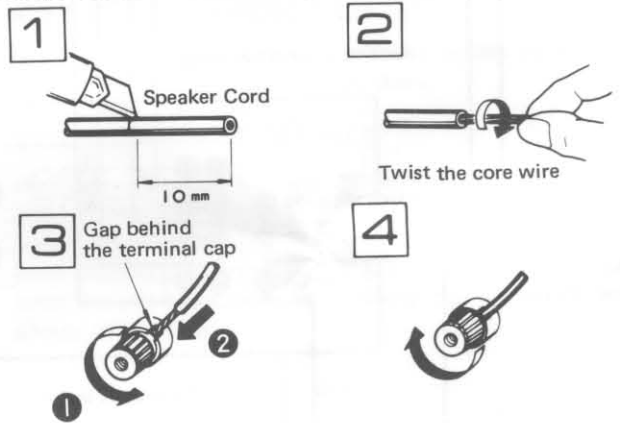

CONNECTING THE SPEAKER SYSTEM

There are two sets of speaker output terminals. When using only one set of speakers, use the upper row A terminals (see diagram below.) Connect the speaker that is on the left when facing the speakers to the L terminal and the one on the right to the R terminal.

- Always join the same poles on the speaker terminals and the speakers themselves (⊕ to ⊕ and ⊖ to ⊖). Otherwise an unnatural sound will result.

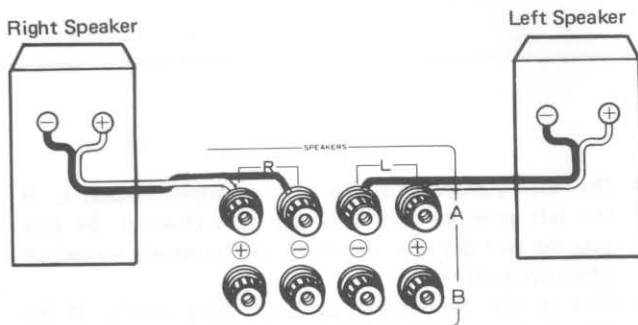

USING THE AC OUTLETS

AC OUTLETS (SWITCHED)

Power supplied through these outlets is turned on and off by the amplifier's POWER switch. Total electrical power consumption of connected equipment should not exceed 100 W.

AC OUTLET (UNSWITCHED)

Power flows continually to this outlet, regardless of whether the amplifier is switched ON or OFF. Electrical power consumption of the connected equipment should not exceed 100 W.

The equipment should be disconnected by removing the mains plug from the wall socket when not in regular use, e.g. when on vacation.

NOTE:

Do not connect appliances with high power consumption such as heaters, irons, or television sets to the AC OUTLETS in order to avoid overheating or fire risk.

This can cause the amplifier to malfunction.

CONNECTING THE COMPONENTS

CONNECTING THE TURNTABLE

Connect the output cord of a turntable to the PHONO jack and the ground wire to the GND terminal. Two different types of cartridges, MC (Moving Coil) and MM (Moving Magnet), can be used by operating the MC/MM switch on the front panel.

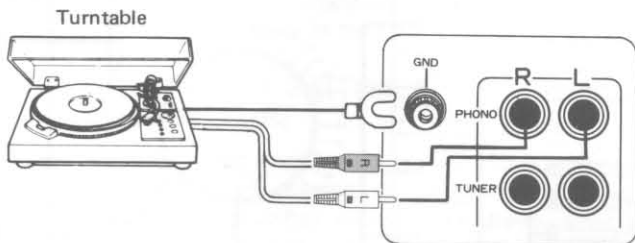

CONNECTING A TAPE DECK

The REC/PLAY jack on the amplifier consist of two sets, TAPE 1 and TAPE 2. It is possible to connect two tape decks to the amplifier and do simultaneous recording or tape to tape recording. When connecting only one tape to the amplifier, connect it to the TAPE 1 jack.

Connecting for Recording

The tape recording jack (TAPE REC) on the tape deck should be connected to the REC side of the TAPE jack on the amplifier with a pin plug connecting cord.

Connecting for Playback

Connect the TAPE PLAY jack on the tape deck and the PLAY side of the TAPE jack on the amplifier with a pin plug connecting cord.

CONNECTING THE TUNER

The output jack on the tuner (OUTPUT) and the tuner input jack on this amplifier (TUNER) are connected by a pin plug connecting cord.

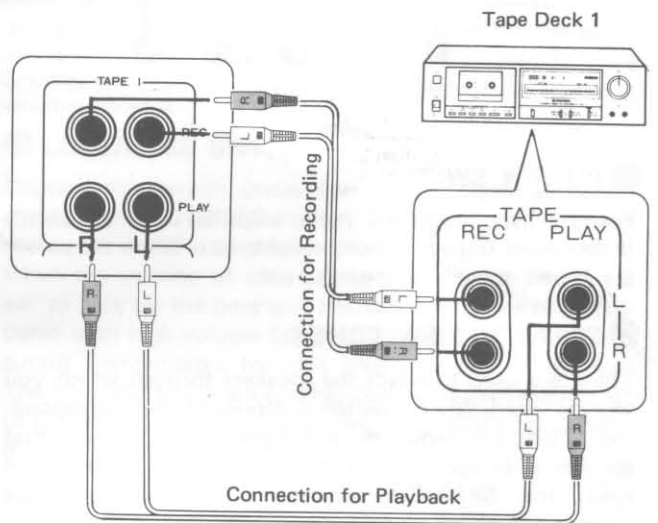
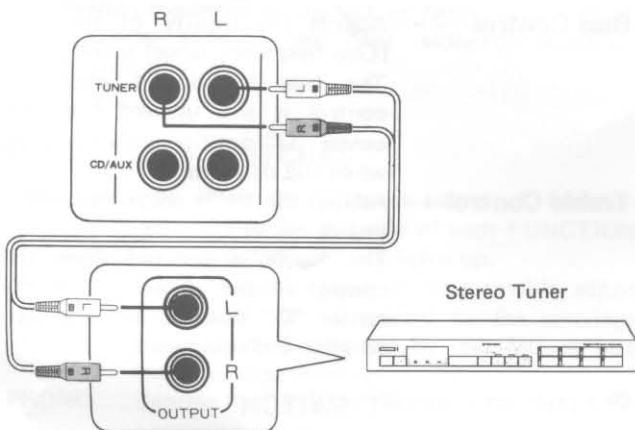

CONNECTING THE CD/AUX TERMINAL

The auxiliary input jack (CD/AUX) can be used for Compact Disc Player or playback-only tape decks etc. The output jack (OUTPUT) of the component to be used and the CD/AUX jack on the amplifier should be connected by a pin plug connecting cord.

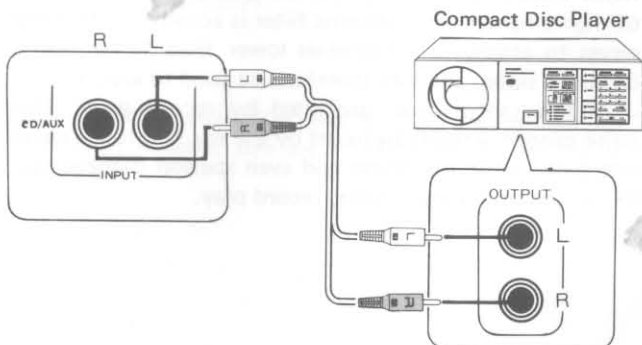

FRONT PANEL FACILITIES

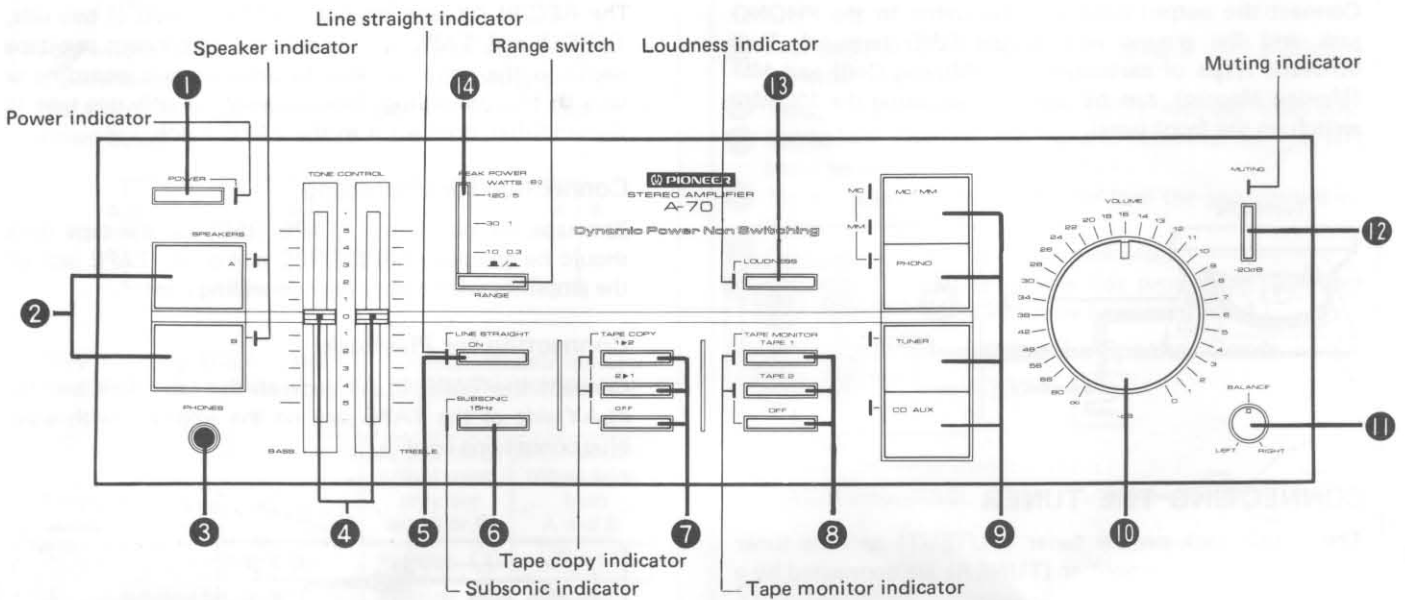

1 POWER SWITCH

Power is supplied to the stereo amplifier when the switch is depressed (Power indicator lights up). When the switch is released, the power is turned off.

2 SPEAKERS SWITCHES

These are used to select the speakers through which you wish to listen. When a switch is depressed, the corresponding SPEAKER indicator will light up to indicate that speaker is in operation. If the same switch is depressed again, the SPEAKER indicator will go out, and that speaker will no longer be in operation.

- A: When the speakers connected to A terminals are in use.
- B: When the speakers connected to B terminals are in use.
- Turn both A and B speaker switches to OFF position when only the HEADPHONES are in use.

NOTE:

When only one set of speakers is used, the impedance is different from that obtained when two sets are used. Read the instructions on Page 6, regarding operation of the SPEAKER IMPEDANCE switch and adjust correctly.

3 PHONES JACK

Connect the plug on your headphones to this jack. To listen to a program through the headphones, turn both the SPEAKER A and B switches to OFF position.

4 TONE CONTROLS (BASS AND TREBLE)

The controls can be adjusted when the LINE STRAIGHT switch is set to OFF position (The Line Straight indicator turns off).

Bass Control..... Adjusts the quality of the Bass (Low frequency range) sound. The bass is boosted when the control is slid upward from the center "O" position and attenuated when slid downward.

Treble Control..... Adjusts the treble (high frequency) sound. The treble is boosted when the control is slid upward from the center "O" position and attenuated when slid downward.

5 LINE STRAIGHT SWITCH

When the switch is depressed to the ON position, (the Line Straight indicator lights up) the signal from the input jacks is sent directly to the power amplifier, without passing through the tone control circuit or the loudness circuit, and consequently a flat frequency response is obtained.

6 SUBSONIC SWITCH

When this switch is depressed, the Subsonic Filter indicator lights up and the subsonic filter is activated. The filter serves to attenuate frequencies lower than 15 Hz with a 6 dB/oct slope, and can therefore be used to suppress the ultra low range noise, generated by record warp. This noise cannot actually be heard by the ear, but it can cause intermodulation distortion and even speaker damage. Use the switch as required during record play.

7 TAPE COPY SWITCHES (TAPE COPY)

When using two tape decks to copy a tape, use these switches. When pressed, the indicator lights up.

1 ▶ 2 When recording from tape deck 1 to tape deck 2, push this switch.

2 ▶ 1 When recording from tape deck 2 to tape deck 1, push this switch

OFF Push when not copying a tape.
Normally leave in the OFF position.

8 TAPE MONITOR SWITCHES (TAPE MONITOR)

These are used when monitoring the recording or playback of a tape. When pressed, the indicator lights up.

TAPE 1 Push to monitor recording or playback of a deck connected to the PLAY jack of TAPE 1.

TAPE 2 Push to monitor recording or playback of a deck connected to the PLAY jack of TAPE 2.

OFF Push when not monitoring recording or playback of a tape.

NOTE:

Simultaneous monitoring or playback of TAPE 1 and TAPE 2 is not possible. Make sure that TAPE MONITOR switch is pressed down firmly.

9 FUNCTION SWITCHES

These switches select the program source. A function indicator is attached to the left side of each FUNCTION switch. When pressed, the indicator lights up.

MC/MM When playing a record on the turntable, adjust the switch to correspond to the cartridge being used. Confirmed by the MC or MM indicator that lights up.

PHONO Depress for playing records on a turntable connected to the PHONO jack on the rear panel.

TUNER Depress for listening to a program on a tuner connected to the TUNER jacks on the rear panel.

CD/AUX Depress for listening to the sound from a stereo component connected to the CD/AUX jacks on the rear panel. (for eg. the Compact Disc Player or TV tuner, which can be bought separately).

NOTE:

Since the TAPE MONITOR switches have priority over the FUNCTION switches, turn the TAPE MONITOR switches to OFF.

10 VOLUME CONTROL

This is used to adjust the volume of sound heard through the speakers or headphones. No sound is heard when the control is at the "∞" position. To increase the volume, turn the control slowly clockwise (↻).

11 BALANCE CONTROL

This is used to adjust the balance of sound from the left and right channels. To increase the volume of the right channel, turn the control clockwise (↻) from the centre position. To increase the volume of the left channel, turn counter-clockwise (↺).

12 MUTING SWITCH (MUTING-20dB)

When this switch is pushed the MUTING indicator comes on and the volume level falls by 20 dB.

This control is effective in record playing when the stylus is lowered onto the record disc, when it is necessary to decrease the volume level temporarily and for fine volume adjustments when playing at low volume levels.

13 LOUDNESS SWITCH

Depress this switch under low volume listening conditions. The LOUDNESS indicator lights up and the bass and treble sound is emphasised.

When the volume of sound is low, the capability of the ear to pick up the bass and treble sound drops off, compared with high volume listening conditions. The loudness circuit compensates for this characteristic of the ear. The bass and treble are emphasized when the switch is set to ON and the sound comes alive, even when the volume is low.

NOTE:

The LOUDNESS switch does not operate if the LINE STRAIGHT switch is ON.

14 PEAK POWER INDICATOR (PEAK POWER WATTS/8 Ω)

This indicator shows in 6 stages the output level when a speaker system with an impedance rating of 8 Ω is connected to the amplifier's speaker terminals.

The range switch operates as follows

- : When in the released position, high level output (120, 30, 10) is shown in watts.
- : When in the depressed position, low level output (5, 1, 0.3) is shown in watts.

OPERATION

BEFORE DEPRESSING POWER SWITCH

Before turning the power on, check that the knobs and switches are as follows.

- 1 The VOLUME control should be turned as far as possible to the left (counter-clockwise).
- 2 The BASS and TREBLE controls should be in the central position.
- 3 The BALANCE control should be in the central position.
- 4 The TAPE MONITOR switch should be OFF.
- 5 The TAPE COPY switch should be OFF.
- 6 The appropriate SPEAKERS switch for whichever output the speakers are connected to on the rear panel should be selected.
- 7 The speaker impedance and the SPEAKER IMPEDANCE switch on the rear panel should be in agreement.
- 8 Always check that all connections to terminals on the rear panel are secure.

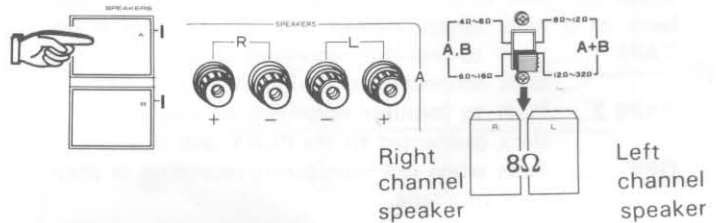
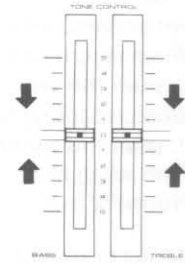
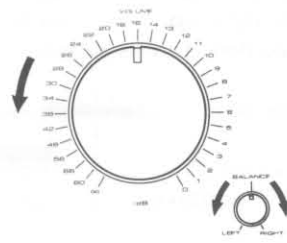

HOW TO ADJUST THE TONE QUALITY

Depending on the characteristics of the speaker system and the listening room the tone quality may change as sound is absorbed or reflected. These factors can be adjusted, or the BASS or TREBLE can be strengthened or weakened. When playing at low volume levels a more natural sound can be obtained by turning the LOUDNESS switch on.

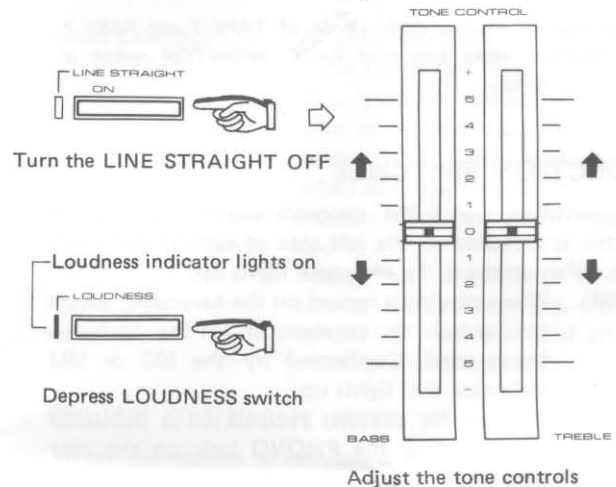

RECORD PLAYING

A turntable connected to the PHONO jack can be played using two different types of cartridge, the MC (Moving Coil) and the MM (Moving Magnet).

- 1 Press the PHONO function switch.
- 2 Set the MC/MM switch to the type of cartridge to be used.
- 3 Operate the turntable and start playing records. For details, see the operating instructions for your turntable.
- 4 Adjust the volume, balance and tone (LINE STRAIGHT should be OFF) etc. and enjoy the music.
- 5 When warped records are played, this generates ultra low range noise which causes intermodulation distortion. In this situation the ultra low range noise can be eliminated by turning the SUBSONIC FILTER switch ON.

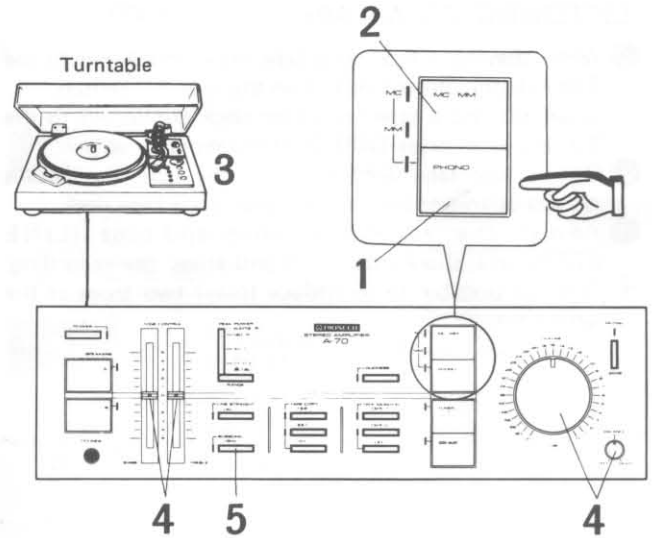

LISTENING TO BROADCASTS

- 1 Press the TUNER function switch.
- 2 Operate the tuner to receive the broadcast. For details, see the operating instructions for your tuner.
- 3 Adjust the volume, balance and tone (LINE STRAIGHT should be OFF) and enjoy the broadcast.

NOTE:

To receive a broadcast clearly, it is necessary to use an antenna suitable for the type of radio waves that will be received. Choose your antenna in accordance with the operating instructions for your tuner.

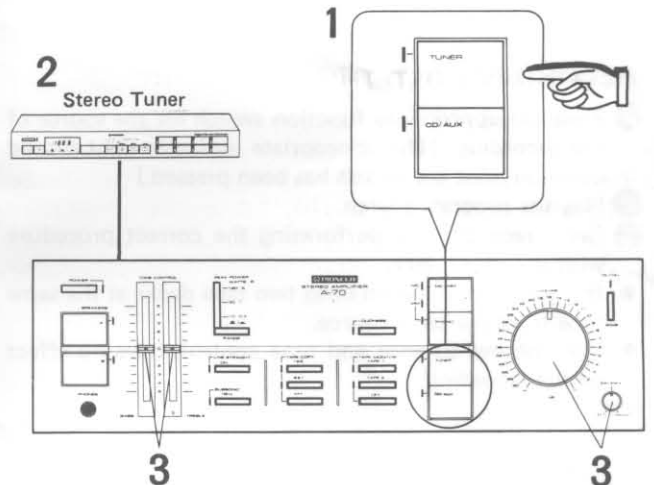

WHEN PLAYING OTHER COMPONENTS

- 1 Press the CD/AUX function switch.
- 2 Operate the component connected to the CD/AUX jack and begin playing.
- 3 Adjust the volume, balance and tone (LINE STRAIGHT should be OFF) and enjoy the program.

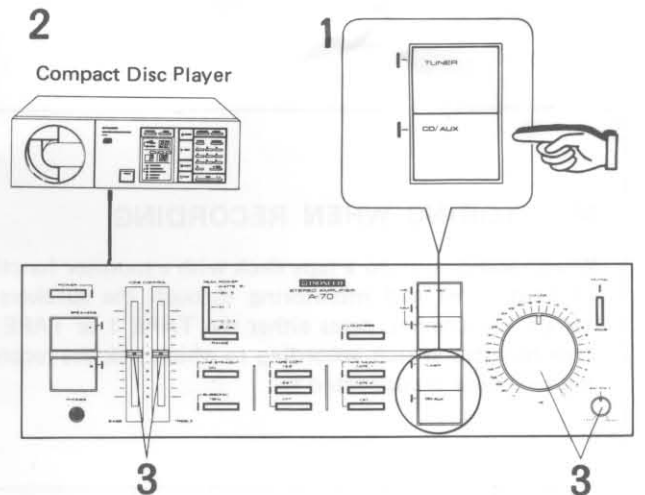

LISTENING TO A TAPE

- 1 When playing a tape on a tape deck connected to the TAPE 1 jack, press TAPE 1 on the monitor switch. When playing a tape on a tape deck connected to the TAPE 2 jack, press TAPE 2 on the monitor switch.
 - 2 Operate the tape deck and play the tape. For details see the operating instructions with your tape deck.
 - 3 Adjust the volume, balance and tone (LINE STRAIGHT should be OFF) and enjoy the recording.
- It is not possible to reproduce (play) two tapes at the same time.

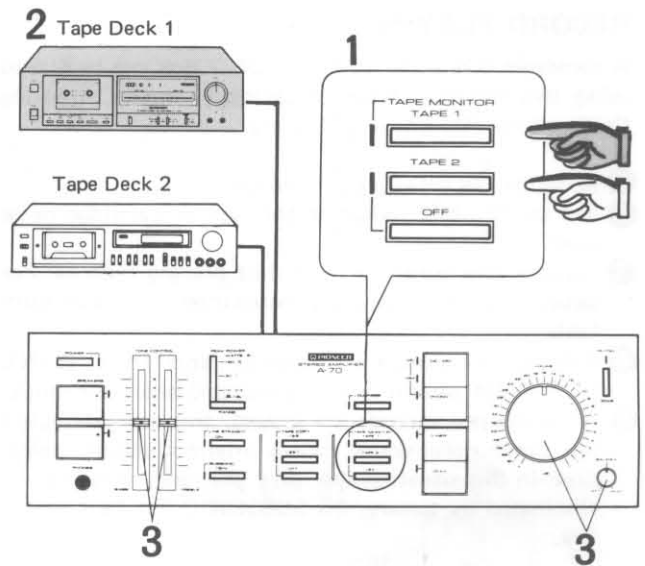

RECORDING A TAPE

- 1 Press the appropriate function switch for the source of the recording. (The appropriate indicator light should come on once the switch has been pressed.)
 - 2 Play the program source.
 - 3 Begin recording by performing the correct procedure with your tape deck.
- It is possible to record onto two tape decks at the same time from the same source.
 - The volume, balance and tone controls have no effect on the recording.

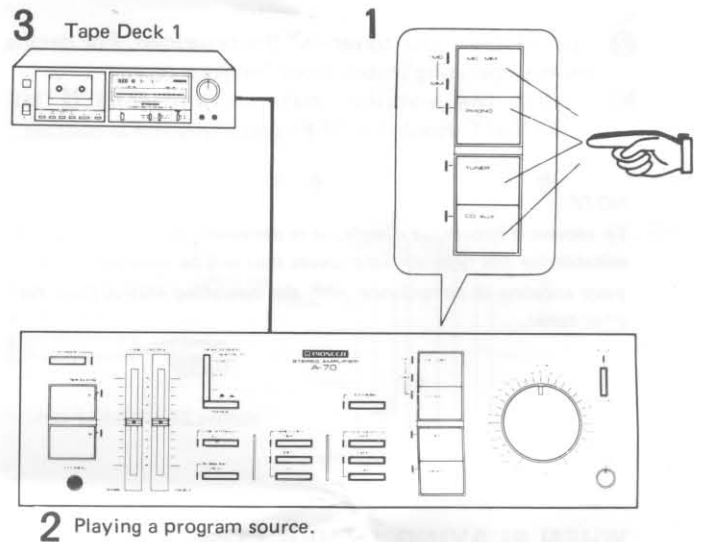

MONITORING WHEN RECORDING

When recording onto a tape deck with a monitor function (3 head type) and monitoring through the speakers or stereo headphones, press either the TAPE 1 or TAPE 2 tape monitor switch according to which jack the recording tape deck is connected to.

When using a 2 head type tape deck, it is not possible to monitor the recording even by operating the function switches. It is however possible to hear the recording from the program source.

TAPE COPYING

If you have two tape decks it is possible to copy and edit into a second tape section from a previously recorded FM music broadcast etc.

- ① Connect the two tape decks to the TAPE 1 and TAPE 2 jacks on the rear panel.
- ② When copying from the tape deck connected to TAPE 1 to the deck connected to TAPE 2, press the tape copy switch 1 ► 2.
When copying from the tape deck connected to TAPE 2 to the tape deck connected to TAPE 1, press the tape copy switch 2 ► 1.
- It is possible with this amplifier to listen to a chosen program source while copying from one tape to another (1 ► 2 or 2 ► 1). For example while copying from tape deck 1 to tape deck 2, it is possible to listen to a radio broadcast by pressing the TUNER function switch.

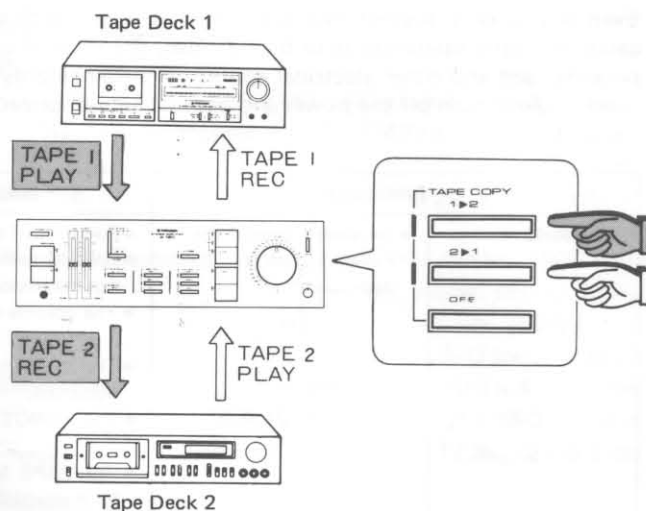

TROUBLESHOOTING

Even if you only suspect that something is wrong with your amplifier, it is wise to proceed with simple checks. In many cases, improper operation is to blame. Also, the cause may lie outside the amplifier. Take the time to check the stereo components used and other electrical appliances being employed simultaneously. If the trouble is not remedied by following the checks below, turn off the power and contact an authorized Pioneer service station.

Symptoms	Suspected Origin of Fault	Remedy	
No Sound	<ul style="list-style-type: none"> ● No sound, even if the Power Switch is depressed. 	<ul style="list-style-type: none"> ● Power cord detached. ● Speaker switch not depressed, or does not correspond to speakers being used. ● The volume control is too low. ● The speaker cord or connecting cord is detached. ● The FUNCTION switch is not depressed. ● The TAPE MONITOR switch is not at OFF position. 	<ul style="list-style-type: none"> ● Insert power cord securely. ● Depress speaker switch correctly. ● Turn the VOLUME control slowly clockwise. ● Connect properly. ● Depress the FUNCTION switch to the program source you wish to listen to. ● Depress the TAPE MONITOR switch securely to OFF position.
	<ul style="list-style-type: none"> ● Sound heard in one channel only. 	<ul style="list-style-type: none"> ● BALANCE control has been turned fully to one side. ● The speaker cord or connecting cord detached. 	<ul style="list-style-type: none"> ● Balance right and left to correspond to the acoustics of the room. ● Connect properly.
Sound Distorted	<ul style="list-style-type: none"> ● Tone quality cannot be adjusted. 	<ul style="list-style-type: none"> ● LINE STRAIGHT switch is at ON position. 	<ul style="list-style-type: none"> ● Operate the tone quality control by turning the LINE STRAIGHT switch to OFF position.
	<ul style="list-style-type: none"> ● No stereo effect. 	<ul style="list-style-type: none"> ● The speaker cord connector does not correspond to the polarity of the amplifier. 	<ul style="list-style-type: none"> ● Correctly align the polarity of speakers and amplifier (⊕ , ⊖).
	<ul style="list-style-type: none"> ● Bass or treble quality poor. 	<ul style="list-style-type: none"> ● Tone quality control setting unsuitable. ● Position of speakers unsuitable. 	<ul style="list-style-type: none"> ● Adjust to align with the room conditions. ● Change the position of the speakers.
	<ul style="list-style-type: none"> ● Sound distorted. 	<ul style="list-style-type: none"> ● Permissible input of the speaker in use is too small. Or the volume is too high. 	<ul style="list-style-type: none"> ● Reduce the volume of the amplifier.
	<ul style="list-style-type: none"> ● Low droning noise (humming or buzzing). 	<ul style="list-style-type: none"> ● Power cord or fluorescent lamp too near the connecting cord. 	<ul style="list-style-type: none"> ● Keep electrical appliances as far away as possible.
Other Trouble	<ul style="list-style-type: none"> ● No tape copying possible. 	<ul style="list-style-type: none"> ● The connection faulty. Or TAPE COPY switch is not depressed. 	<ul style="list-style-type: none"> ● See section on TAPE COPYING and operate correctly.

SPECIFICATIONS

Amplifier Section

Continuous Average Power Output is 120 watts* per channel, min., at 8 ohms from 20 Hertz to 20,000 Hertz with no more than 0.003 % total harmonic distortion.**

Continuous Power Output at 1kHz
(both channel driven)

T. H. D. 0.003% , 8 ohms 130watts per channel

T.H.D. 0.1% , 8 ohms 140 watts per channel (DIN)

Total Harmonic Distortion (20 Hertz to 20,000 Hertz, 8 ohms)

continuous rated power output
. **No more than 0.003%

60 watts per channel power output
. **No more than 0.003%

Intermodulation Distortion (50 Hertz: 7,000 Hertz = 4:1, 8 ohms)

continuous rated power output
. No more than 0.003%

Damping Factor (20 Hertz to 20,000 Hertz, 8 ohms)
. 60

Input (Sensitivity/Impedance)

PHONO MM 2.5mV/50 kilohms

PHONO MC 200 μ V/100 ohms

TUNER, CD/AUX, TAPE PLAY 1, 2
. 150 mV/50 kilohms

Phono Overload Level (T.H.D. 0.005%, 1,000Hz)

PHONO MM 150mV

PHONO MC 11mV

Output (Level/Impedance)

TAPE REC 1, 2 150mV/2.2 kilohms

Frequency Response

PHONO (RIAA Equalization)
. 20Hz to 20,000Hz \pm 0.2dB

TUNER, CD/AUX, TAPE PLAY 1, 2
. 5Hz to 100,000Hz $\begin{matrix} +0 \\ -3 \end{matrix}$ dB

Tone Control

BASS \pm 10dB (100Hz)

TREBLE \pm 10dB (10kHz)

Filter

LOW (SUBSONIC) 15Hz (-6dB/oct.)

Loudness Contour (Volume control set at -40dB)

. +6dB (100Hz), +3dB (10kHz)

Hum and Noise (IHF, short circuited A network)

PHONO MM 87dB

PHONO MC 70dB

TUNER, CD/AUX, TAPE PLAY 1, 2 108dB

Hum and Noise (DIN, continuous power/50mW)

PHONO MM 74dB/61dB

TUNER, CD/AUX, TAPE PLAY 1, 2 88dB/62dB

Muting -20dB

Miscellaneous

Power Requirements

. KU, KC models; AC 120V, 60Hz
HE, HB, YP models; a. c. 220/240Volts \sim (switchable),
50/60Hz

S, S/G models; AC 110/120/220/240V (switchable),
50/60Hz

Power Consumption KU model; 450W (UL)

KC model; 550VA (CSA)

HE, HB, YP models; 780W (max.)

S, S/G models; 260W

Dimensions 420(W) x 131(H) x 411(D) mm

16-9/16(W) x 5-3/16(H) x 16-3/16(D) in

Weight (without package) 12.3kg (27 lb 2 oz)

Furnished Parts

Operating Instructions 1

**Measured pursuant to the Federal Trade Commission's Trade Regulation rule on Power Output Claims for Amplifier.*

*** Measured by Shibasoku 725 Automatic Distortion Analyzer.*

NOTE:

Specifications and designa subject to possible modification without notice.

REVISIONS

SPECIFICATIONS

PIONEER ELECTRONIC CORPORATION 4-1, Meguro 1-Chome, Meguro-ku, Tokyo 153, Japan
PIONEER ELECTRONICS (USA) INC. 1925 E. Dominguez St., Long Beach, California 90810 U.S.A.
PIONEER ELECTRONIC (EUROPE) N.V. Keetberglaan 1, 2740 Beveren, Belgium
PIONEER ELECTRONICS AUSTRALIA PTY. LTD. 178-184 Boundary Road, Braeside, Victoria 3195, Australia

<83J01Y4D06>

Printed in Japan <ARB-560-0>